



60W LED Wall Packs

Outdoor Non-Cutoff and Semi-Cutoff Wall-Mounted Area Luminaires

Features & Benefits:

- Great Energy Savings !
- 5-Years | 50,000 Hours Warranty (*)
- High Power Factor – UL Listed Driver
- Bright – High CRI – High Lumen Output
- Built-in Surge Suppressors & Protection
- CCT 5,000K ideal for MH Lamps Replacement



Model	Product	Power	Flux	Equivalent
WP-60W-55K-277V	LED Wall Pack 60W 110° 120-277VAC	(W) 14¼" (H) 9¼" (D) 7¾"	60W	6,600lm

- 120-277Vac ~50/60Hz • Pigtail Wire • P.F. > 0.9 • THD < 20% •
- "55K" = CCT 5000K ±10% • CRI ≈ 75 • ~124 lm/W •
- (*) Rated Life > 50,000 Hrs. (L₇₀ B₅₀) at T_A 25°C Max. •

60W LED Wall Pack

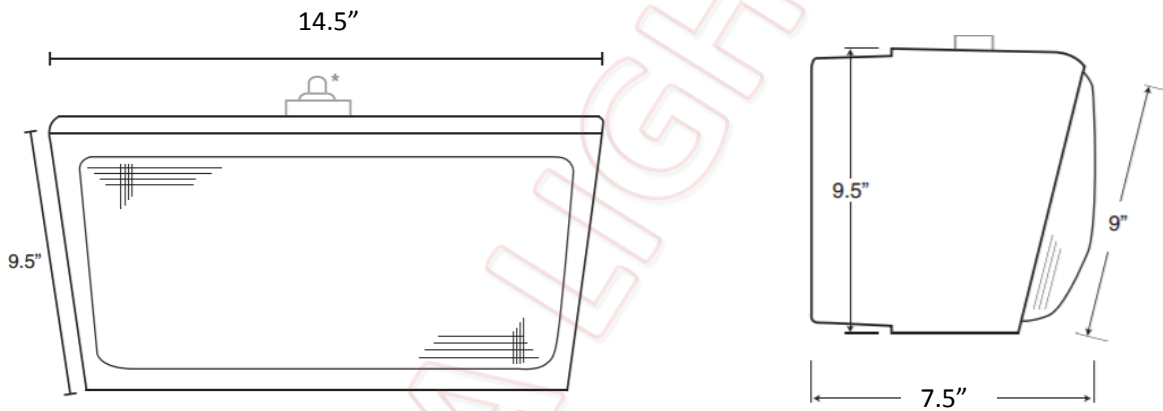
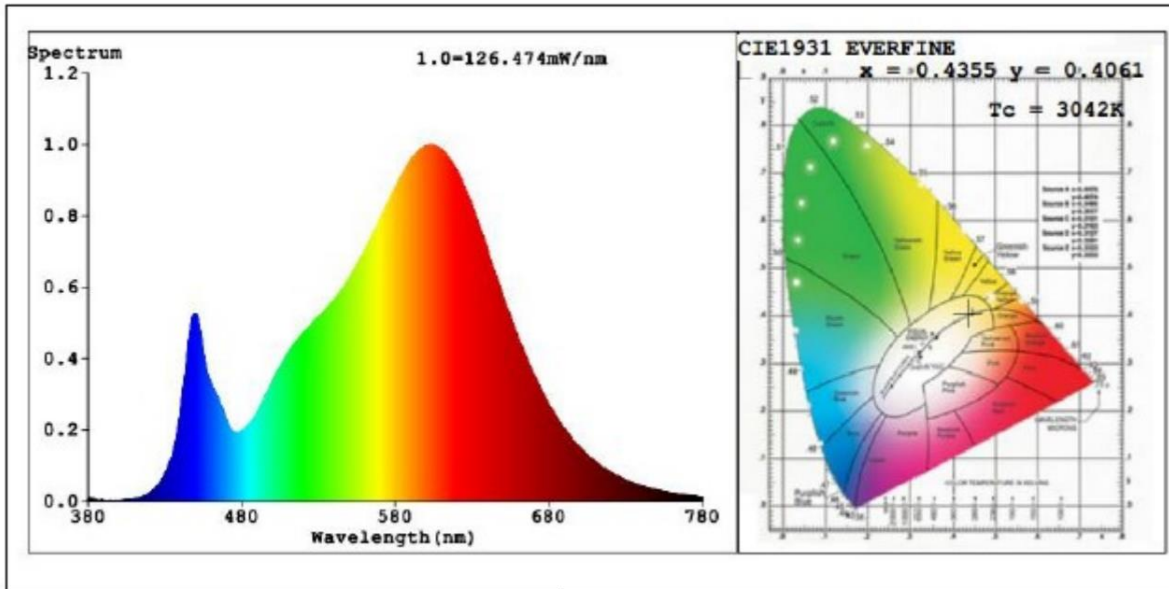

Model	Product	Power	Equivalent
WP-60W-55K-277V	Wall Pack LED Fixture 60W CCT 5500K	60W	250W MH Lamp
Input Voltage	Power/Power Factor	Efficacy	Flux
"277V": 120-277Vac ~50/60Hz "480V": 208-480Vac ~50/60Hz	60W Max. P.F. ≈ 0.97	~110 lm/W	6,600 Lumen
Color Rendering	Color Temperature	Beam Angle	Life
CRI ÷ 75~80	CCT 5500K ±10%	110°	50,000 Hours (L ₇₀ B ₅₀) T _[A] 25°C Max.